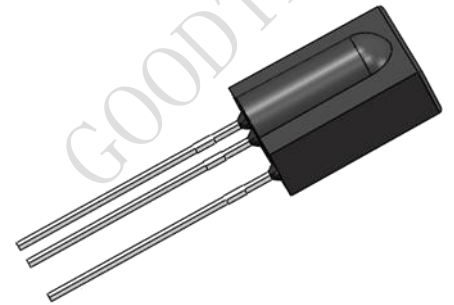

Photo Module for PCM Remote Control Systems

Description

The AT438A is miniaturized receiver for use infrared carrier frequency PCM remote control systems. A photo PIN diode and a low noise preamplifier are assembled on lead frame, the epoxy package is designed as IR filter.

The demodulated output signal can directly be decoded by a microprocessor. The main benefit is the reliable function even in disturbed ambient and the protection against uncontrolled output pulses.



Features

- Photo detector and Preamplifier in one package
- Internal filter for PCM frequency
- TTL and CMOS compatibility
- Output active low
- Wide supply voltage & low current dissipation
- Suitable burst length ≥ 15 cycles/burst

Special Features

- Enhanced immunity against all kinds of disturbance light
- No occurrence of disturbance pulses at the output

Applications

TV, VTR, Acoustic Devices, Air Conditioner, Car Stereo Units, Computers, Interior controlling appliances, and all appliances that require remote controlling

Block Diagram

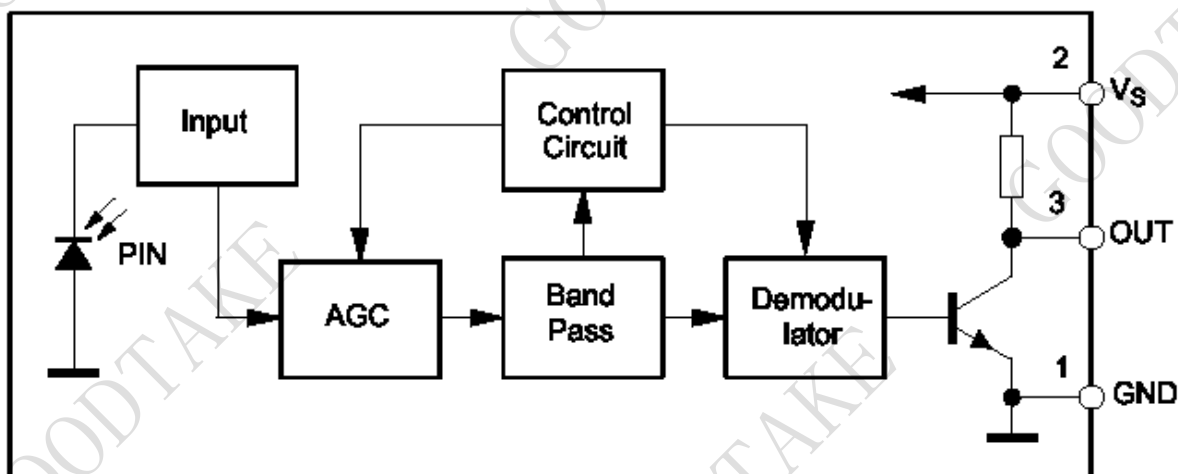

Application Circuit

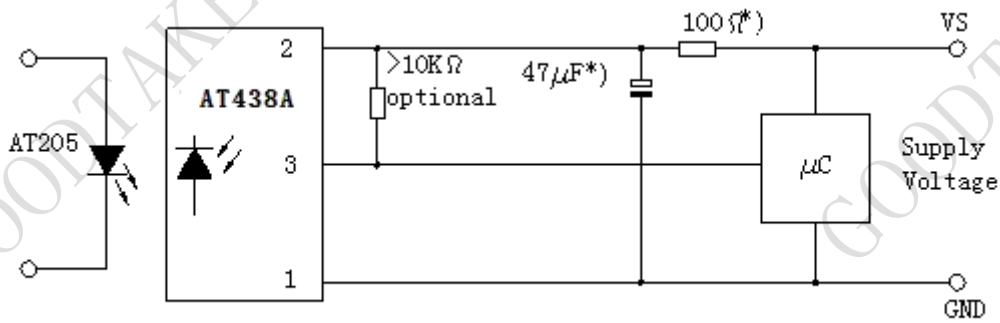

*) recommended to suppress power supply disturbance

Absolute Maximum Ratings

Tamb = 25 °C

Parameter	Test Conditions	Symbol	Value	Unit
Supply Voltage	(Pin 2)	Vs	-0.3...6.0	V
Supply Current	(Pin 2)	Is	3	mA
Output Voltage	(Pin 3)	Vo	-0.3...6.0	V
Storage Temperature Range		Tstg	-25...+85	°C
Operating Temperature Range		Tamb	-25...+85	°C
Power Consumption		ptot	18	mW
Soldering Temperature	t ≦ 5s, 1 mm from case	Tsd	260	°C

Basic Characteristics

Tamb = 25 °C

Parameter	Test Condition	Symbol	Min	Typ	Max	Unit
Supply current	Vs = 5V, Ev = 0	Is		0.45	0.80	mA
	Vs = 3V, Ev = 0		0.15	0.35		
Operating Voltage	(Pin 2)	Vs	2.7	3.0	5.5	V
Transmission distance	IR diode AT205, IF = 400mA, Ev = 0		22	25		m
The minimum distance between the remote control and the receiver	IR diode AT205, IF = 400mA		0.3			m
Output Voltage High	Vs = 5V	VOSH	4.5			V
Output Voltage Low	IOSL = 2 mA, f = fo, tp/T = 0.4	VOSL			400	mV
Peak Wavelength	Internal IR filter	λ		940		nm
Carrier frequency	Internal BPF	fc		38		kHz
Output pulse width	Input burst = 600µS	Tp	400		800	µS
Angle of 1/2 Distance	Horizontal Half angle	½θ		±45°		Deg

Test Condition:

1. Test signal for output pulse width

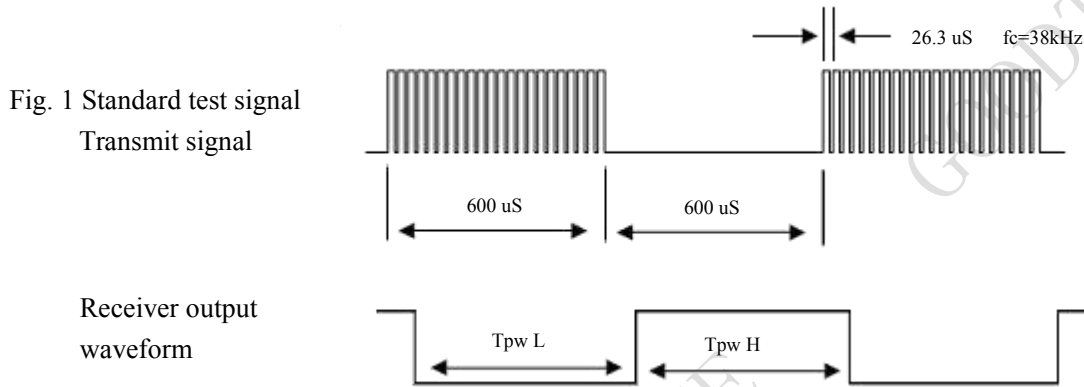

2. Arrival distance

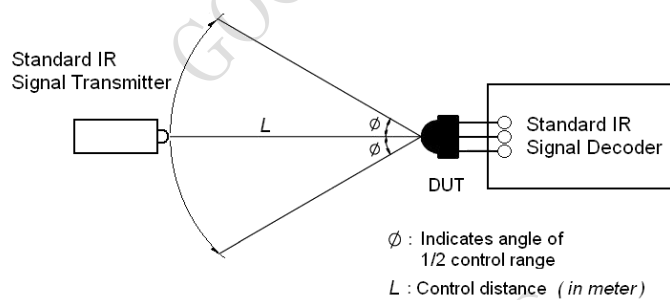

Test condition for measuring the control distance

3. Suitable Data Format

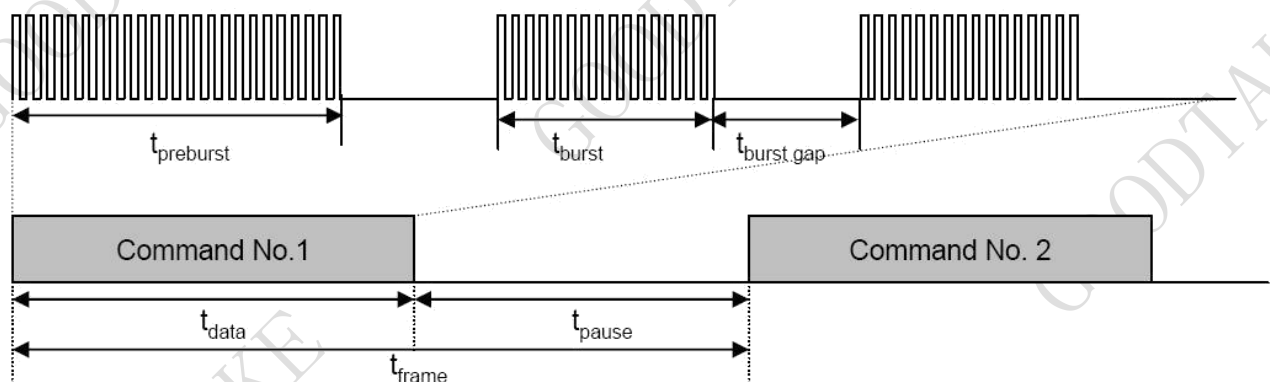

- Minimum burst length (t_{burst}) of 15 pulses per burst
- Minimum burst gap time ($t_{burst\ gap}$) 20pulse
- Minimum data pause time (t_{pause}) > 22msec
- Suitable data format are : NEC Code, RC 5, RC 6 Toshiba

Characteristics Curve(T_{amb}=25°C unless otherwise specified)

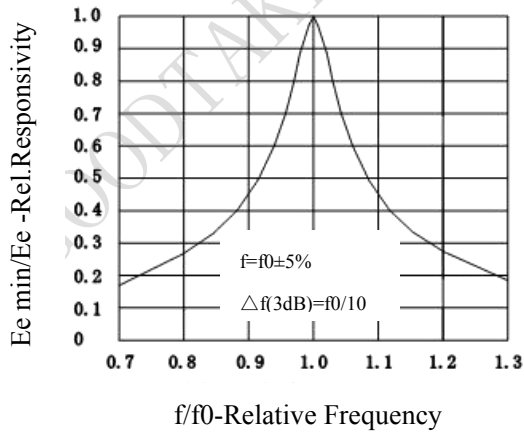

Figure.1-Frequency Dependence of Responsivity

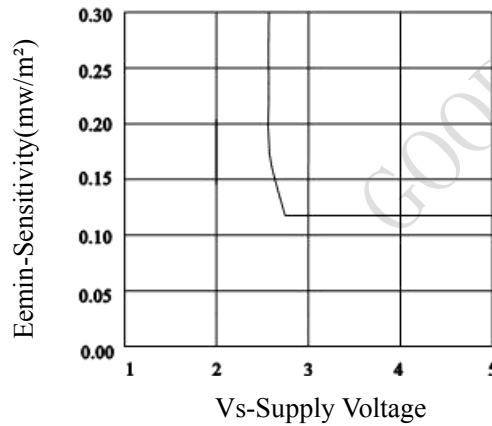

Fig.2-Sensitivity VS. Supply Voltage

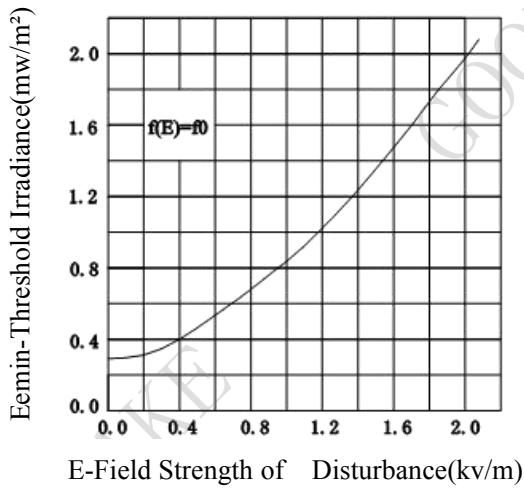

Figure.3- Sensitivity vs. Electric Field Disturbances

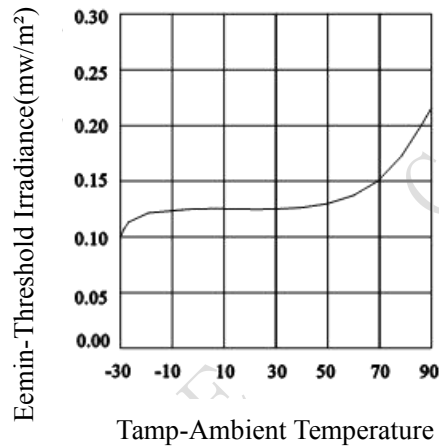

Fig.4-Sensitivity vs. Ambient Temperature

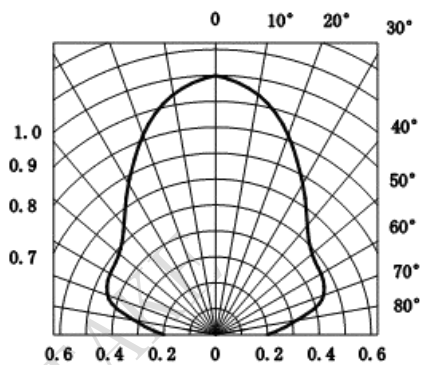

Fig.5-Vertical Directivity

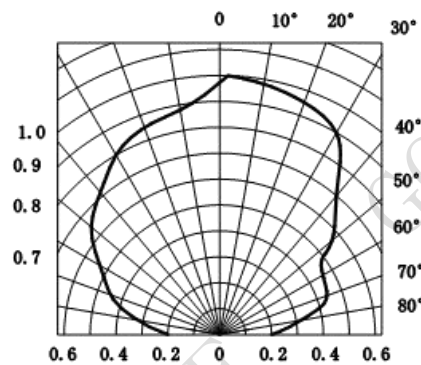

Fig.6-Horizontal Directivity

Reliability Test

TEST ITEM	TEST CONDITION	TEST TIME	SAMPLE NUM	OK NUM
High Temperature Storage	Ta=+85°C	t=240H	22	22
Low Temperature Storage	Ta=-25°C	t=240H	22	22
Resistance to soldering heat	Soak into solder tub of Tsd=260°C	1cycle 5sec	22	22
Electro Static Discharge	HBM C=100pF, R=1.5kΩ, 2kV,	each pin test once	22	22
High Temperature/Humidity*	Ta=+85°C, 90%RH	t=240H	22	22
Heat Cycle*	-25°C~+85°C(0.5H)	20cycle	22	22

Note : *(electro-optical characteristics) shall be satisfied after leaving 2 hours in the normal temperature

Package Outline

Note: tolerance ±0.3mm

